

# JMM5772N

## *Product Preview*

### 40V N-Channel MOSFET

**Features**

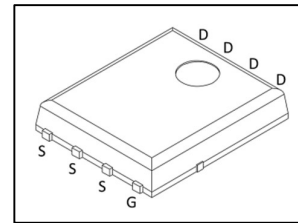
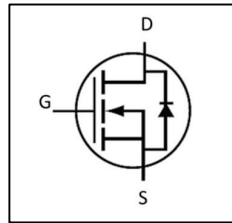
- Advanced shielded-gate technology
- Ultra-low on-resistance and gate-charge
- RoHS compliant
- 100% avalanche tested



Product Summary	
V <sub>DS</sub>	40V
R <sub>DS(ON)</sub>	3.0 mΩ (Typ.)
	3.6 mΩ (Max.)

**Applications**

- Motor controllers
- DC-to-DC convertors
- Battery-driven electronic products, electrical equipment and machines


**Ordering Information**

Part Number	Marking	Package	Packaging
JMM5772N	MM5772N	DFN5x6	Tape & Reel

**Absolute Maximum Ratings**

Parameter	Symbol	Limit	Unit
Drain-to-Source Voltage	$V_{DS}$	40	V
Gate-to-Source Voltage	$V_{GS}$	$\pm 20$	
Continuous Drain Current, Silicon Limited ( $T_C = 25^\circ\text{C}$ ) <sup>(1)</sup>	$I_D$	96	A
Continuous Drain Current, Silicon Limited ( $T_C = 100^\circ\text{C}$ ) <sup>(1)</sup>	$I_D$	61	
Continuous Drain Current, Silicon Limited t ( $T_A = 25^\circ\text{C}$ ) <sup>(2), (3)</sup>	$I_D$	21	
Continuous Drain Current, Silicon Limited ( $T_A = 100^\circ\text{C}$ ) <sup>(2), (3)</sup>	$I_D$	13	
Pulsed Drain Current <sup>(4)</sup>	$I_{DM}$	160	
Power Dissipation ( $T_C = 25^\circ\text{C}$ )	$P_D$	56.8	W
Linear Derating Factor	-	0.45	W/ $^\circ\text{C}$
Single Pulse Avalanche Energy <sup>(5)</sup>	$E_{AS}$	93	mJ
Avalanche Current <sup>(6)</sup>	$I_{AS}$	28	A
Junction Temperature	$T_J$	-55 to 150	$^\circ\text{C}$
Storage Temperature	$T_{STG}$	-55 to 150	

**Thermal Characteristics**

Parameter	Symbol	Max	Unit
Junction-to-Ambient Thermal Resistance <sup>(3)</sup>	$R_{\theta JA}$	45	$^\circ\text{C}/\text{W}$
Junction-to-Case Thermal Resistance	$R_{\theta JC}$	2.2	

**Static Electrical Characteristics <sup>(7)</sup>**

Parameter	Symbol	Test Conditions	Min	Typ	Max	Unit
Drain-to-Source Breakdown Voltage	$BV_{DSS}$	$V_{GS} = 0\text{V}, I_D = 250\mu\text{A}$	40	-	-	V
Gate Threshold Voltage	$V_{GS(TH)}$	$V_{DS} = V_{GS}, I_D = 250\mu\text{A}$	1.1	-	2.2	
Drain-to-Source Leakage Current	$I_{DSS}$	$V_{DS} = 40\text{V}, V_{GS} = 0\text{V}$	-	-	1	$\mu\text{A}$
Gate-to-Source Leakage Current	$I_{GSS}$	$V_{DS} = 0\text{V}, V_{GS} = \pm 20\text{V}$	-	-	$\pm 100$	nA
Drain-to-Source On-Resistance	$R_{DS(ON)}$	$V_{GS} = 10\text{V}, I_D = 20\text{A}$	-	3.0	3.6	m $\Omega$
		$V_{GS} = 4.5\text{V}, I_D = 20\text{A}$	-	4.0	5.2	m $\Omega$

**Dynamic Electrical Characteristics (7)**

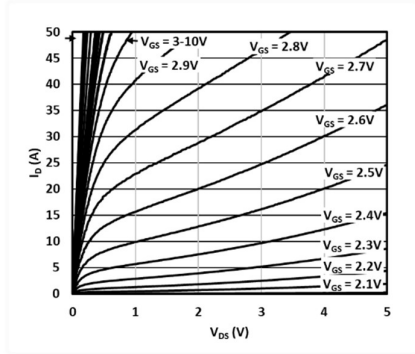
Parameter	Symbol	Test Conditions	Min	Typ	Max	Unit
Forward Transconductance	$g_{fs}$	$V_{DS} = 5V, I_D = 20A$	-	92	-	S
Total Gate Charge	$Q_g$	$V_{GS} = 10V,$ $V_{DS} = 20V,$ $I_D = 20A$	-	22.9	-	nC
Gate-to-Source Charge	$Q_{gs}$		-	3.1	-	
Gate-to-Drain Charge	$Q_{gd}$		-	4.0	-	
Turn-On Delay Time	$t_{d(on)}$	$V_{GS} = 10V,$ $V_{DS} = 20V,$ $I_D = 20A,$ $R_G = 3.0\Omega$	-	4	-	ns
Rise Time	$t_r$		-	5	-	
Turn-Off Delay Time	$t_{d(off)}$		-	20	-	
Fall Time	$t_f$		-	5	-	
Input Capacitance	$C_{iss}$	$V_{GS} = 0V,$ $f = 1MHz,$ $V_{DS} = 20V$	-	1802	-	pF
Output Capacitance	$C_{oss}$		-	710	-	
Reverse Transfer Capacitance	$C_{rss}$		-	76	-	

**Diode Characteristics (7)**

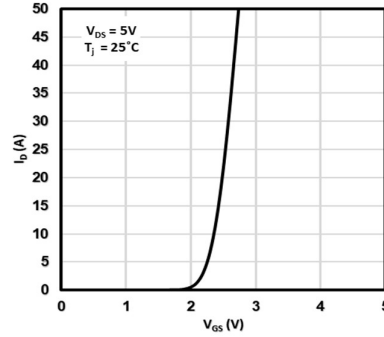
Parameter	Symbol	Test Conditions	Min	Typ	Max	Unit
Forward Voltage	$V_{SD}$	$V_{GS} = 0V, I_S = 20A$	-	0.8	-	V
Reverse Recovery Time	$t_{rr}$	$V_{GS} = 0V, I_S = 20A,$ $di_S/dt = 100A/\mu s$	-	47	-	ns
Reverse Recovery Charge	$Q_{rr}$		-	36	-	nC

- (1) Rated according to  $R_{\theta JC}$
- (2) Rated according to  $R_{\theta JA}$
- (3) Surface-mounted on 1 inch<sup>2</sup> FR4 board, 2 oz Cu
- (4) Limited by maximum  $T_J$
- (5) Starting  $T_J = 25^\circ C, L = 0.1mH, V_{DD} = 30V, V_{GS} = 10V$
- (6) Pulse width limited by maximum  $T_J$
- (7)  $T_J = 25^\circ C$  unless otherwise specified

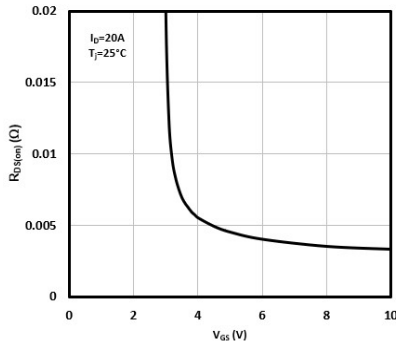
**Typical Electrical Characteristics**



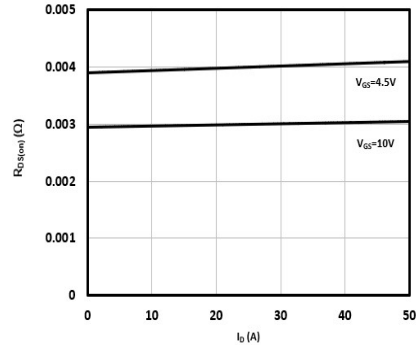
**Fig. 1 Output characteristics**



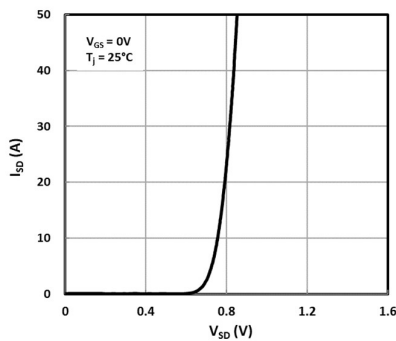
**Fig. 2 Transfer characteristics**



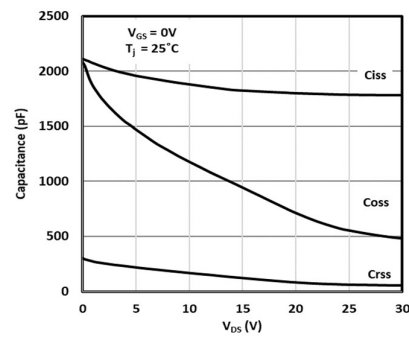
**Fig.3 On-resistance vs. gate voltage**



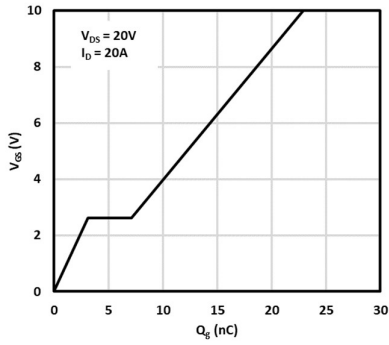
**Fig.4 On-resistance vs. drain current**



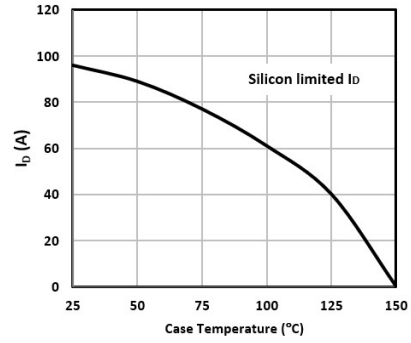
**Fig.5 Source-to-drain diode forward characteristics**



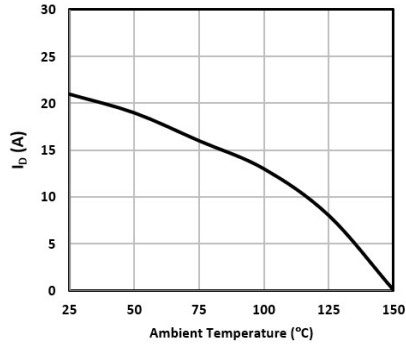
**Fig.6 Capacitance vs. drain-to-source voltage**



**Fig.7** Gate-to-source voltage vs. gate charge

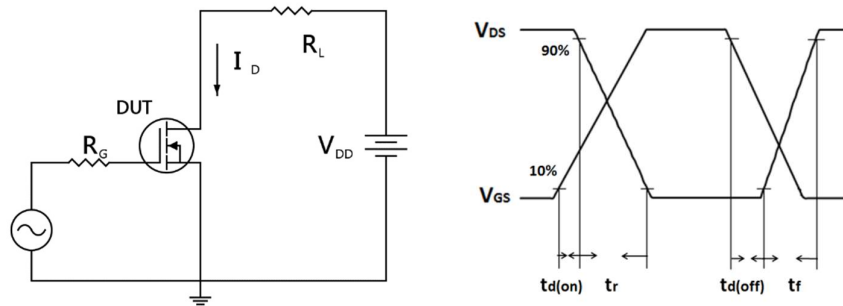


**Fig.8** Maximum drain current vs. case temperature

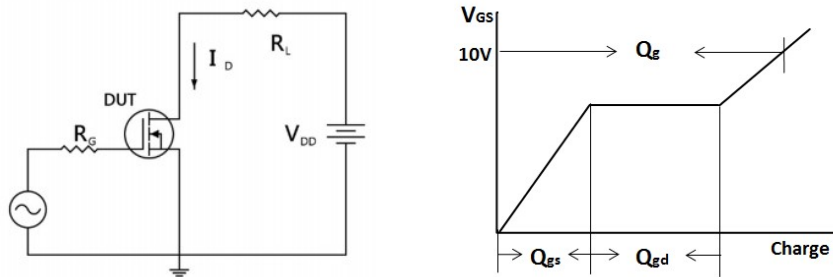


**Fig. 9** Maximum drain current vs. ambient temperature

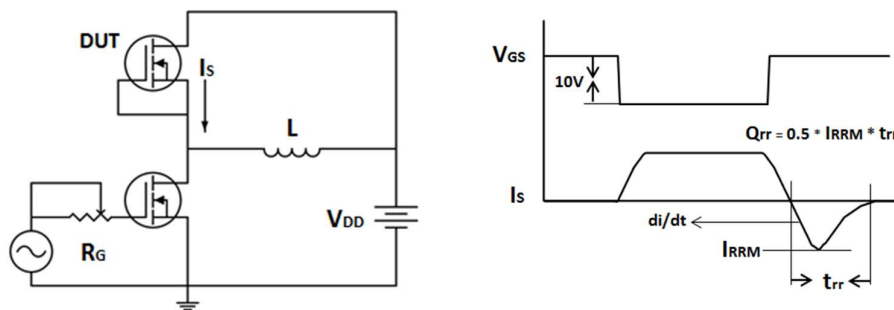
**Test Circuits and Waveforms**



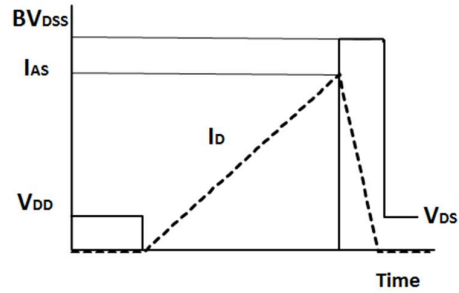
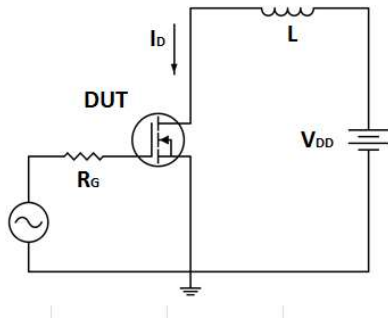
**Resistive switching time test circuit & waveforms**



**Gate charge test circuit & waveform**

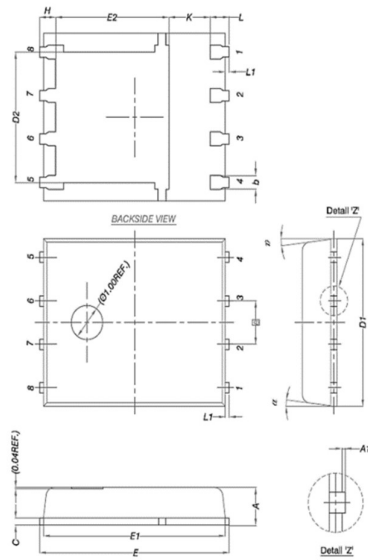


**Peak diode recovery dv/dt test circuit & waveforms**



Unclamped inductive switching test circuit & waveforms

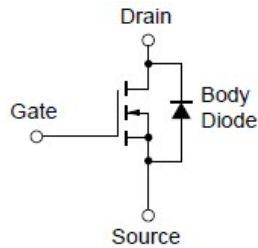
**Package Drawing**



DIM.	MILLIMETERS		
	MIN.	NOM.	MAX.
A	0.90	1.00	1.10
A1	0	-	0.05
b	0.33	0.41	0.51
C	0.20	0.25	0.30
D1	4.80	4.90	5.00
D2	3.61	3.81	3.96
E	5.90	6.00	6.10
E1	5.70	5.75	5.80
E2	3.38	3.58	3.78
[a]	1.27 BSC		
H	0.41	0.51	0.61
K	1.10	-	-
L	0.51	0.61	0.71
L1	0.06	0.13	0.20
α	0°	-	12°

**DFN 5x6**

**Equivalent Circuit**





Revision history of JMM5772N specification

Version	Change Items	Effective Date
1.00	Initial Release	19-Aug-21

---

## Notice

**General** – Information in this document is believed to be accurate and reliable. However, JSAB Technologies does not give any representations or warranties, expressed or implied, as to the accuracy or completeness of such information and shall have no liability for the consequences of use of such information.

**Right to make changes** – JSAB Technologies reserves the right to make changes to information published in this document, including without limitation specifications and product descriptions, at any time and without notice. This document supersedes and replaces all information supplied prior to the publication hereof.

**Suitability for use** – JSAB Technologies' products are not designed, authorized or warranted to be suitable for use in medical, military, aircraft, space or life support equipment, nor in applications where failure or malfunction of an JSAB Technologies product can reasonably be expected to result in personal injury, death or severe property or environmental damage. JSAB Technologies accepts no liability for inclusion and/or use of JSAB Technologies' products in such equipment or applications and therefore such inclusion and/or use is at the customer's own risk.

**Applications** – Applications that are described herein for any of these products are for illustrative purposes only. JSAB Technologies makes no representation or warranty that such applications will be suitable for the specified use without further testing or modification.

**Limiting values** – Stress above one or more limiting values may cause permanent damage to the device. Limiting values are stress ratings only and operation of the device at these or any other conditions above those given in the Characteristics sections of this document is not implied. Exposure to limiting values for extended periods may affect device reliability.

**Terms and conditions of sale** – JSAB Technologies' products are sold subject to the general terms and conditions of commercial sale, including those pertaining to warranty, intellectual property rights infringement and limitation of liability, unless explicitly otherwise agreed to in writing by JSAB Technologies. In case of any inconsistency or conflict between information in this document and such terms and conditions, the latter will prevail.

**No offer to sell or license** – Nothing in this document may be interpreted or construed as an offer to sell products that is open for acceptance or the grant, conveyance or implication of any license under any copyrights, patents or other industrial or intellectual property rights.

**Export control** – This document as well as the item(s) described herein may be subject to export control regulations. Export might require a prior authorization from national authorities.

**Quick reference data** – The Quick reference data is an extract of the product data given in the Limiting values and Characteristics sections of this document, and as such is not complete, exhaustive or legally binding.